



STANDARD FEATURES

- Low weight cast aluminum construction.
- Quiet operation with integral inlet and outlet muffling.
- Recognized TEFC - **cURus** motor.
- High efficiency / low noise impeller design.
- No lubrication / maintenance required.
- Allowed ambient: +5 °F to +104 °F.
- Mountable in any plane.

OPTIONS

- Remote drive models (belt or coupling).
- Special voltages.
- Surface treatment or plating.
- Gas tight sealing.
- Special designs available.

ACCESSORIES

- Inlet and/or inline filters.
- Additional inlet/outlet silencers.
- Safety valves.
- Flow converting devices.
- Optionals connectors

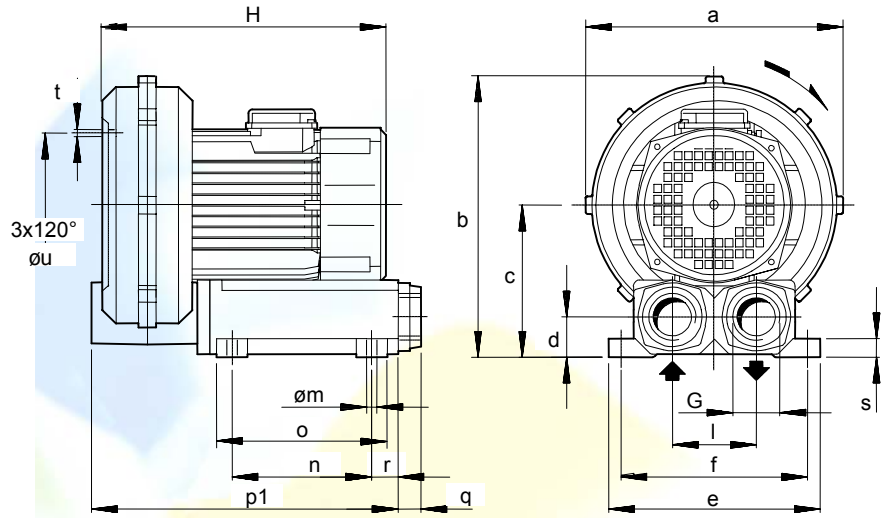

Dimensions in inches.
 Dimension for reference only.

Model	a	b	c	d	e	f	G	l	m	n	o	p1	q	r	s	t	u
20DH	11.42	12.20	6.50	1.77	9.06	8.27	1"1/4 NPT	3.54	0.39	5.90	7.67	13.98	0.71	1.77	0.79	M6	5.91
30DH	12.60	13.66	7.36	2.09	10.63	9.64	1"1/2 NPT	4.13	0.39	7.28	9.25	16.54	0.71	2.17	0.79	M6	7.09
40DH	13.78	14.576	7.68	2.09	10.63	9.65	1"1/2 NPT	4.13	0.39	7.28	9.25	17.32	0.71	2.17	0.79	M8	8.86

Model	Maximum flow Scfm		Installed power Hp		Maximum differential pressure Δp (In WG)		Noise level Lp dB (A) ⁽¹⁾		Overall dimensions H	Weight
	60 Hz	50 Hz	60 Hz	50 Hz	60 Hz	50 Hz	60 Hz	50 Hz		
	3500 rpm	2900 rpm	3500 rpm	2900 rpm	3500 rpm	2900 rpm	3500 rpm	2900 rpm	Inches	Lbs
20DH	48	42	3/4	3/4	54	66	67.4	64.4	13.39	37.40
			1	1	84	94	67.7	64.7	13.78	44.00
			1 1/2	1 1/2	143	140	68.0	65.0	13.78	47.30
30DH	70	61	3/4	-	30	-	68.8	-	13.78	45.10
			1	1	51	64	69.1	67.1	14.37	51.70
			1 1/2	1 1/2	96	108	69.4	67.4	14.37	55.00
			2	2	140	153	69.7	67.7	15.36	58.30
40DH	98	85	3	3	151	156	74.7	71.7	16.54	71.50
			4	4	201	201	75.0	72.0	18.31	80.30

(1) Noise measured at 1 m distance with inlet and outlet ports piped, in accordance to ISO 3744.

- For proper use, the blower should be equipped with inlet filter and safety valve; other accessories available on request.
- Ambient temperature from +5° to +104°F.
- Specifications subject to change without notice.



REGENERATIVE BLOWERS - PRESSURE
SCL 20DH / 30DH / 40DH
MOR RANGE
 SN 2191-1 2/2

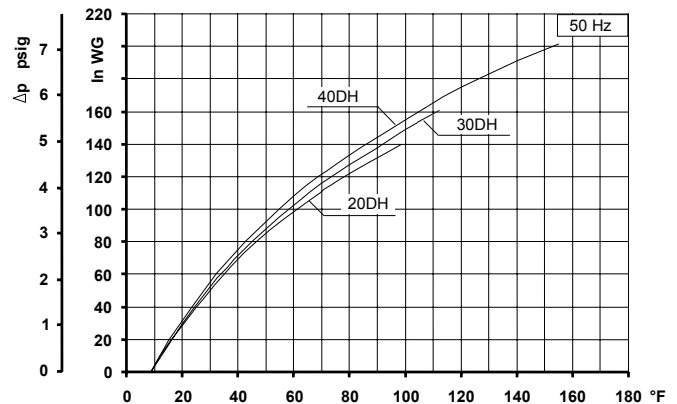
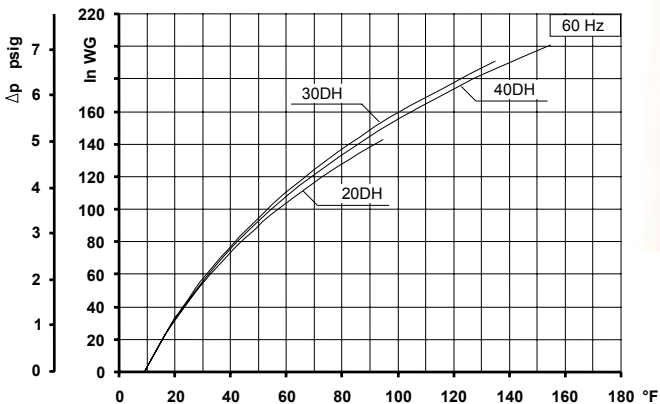
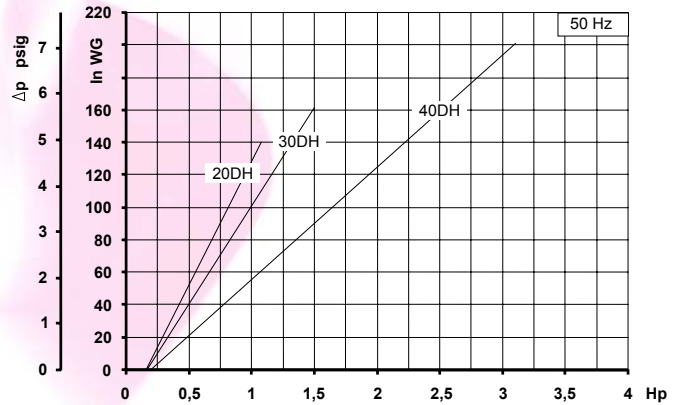
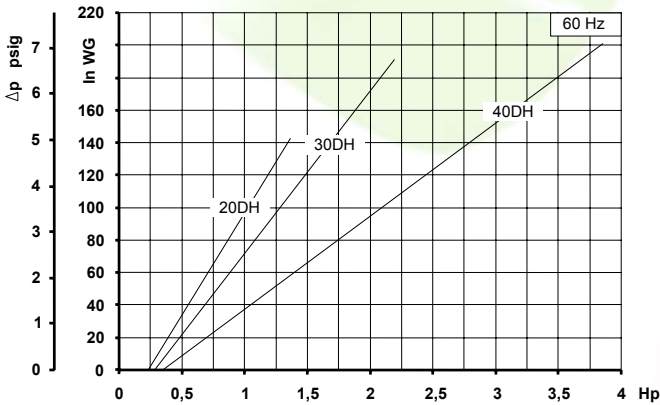
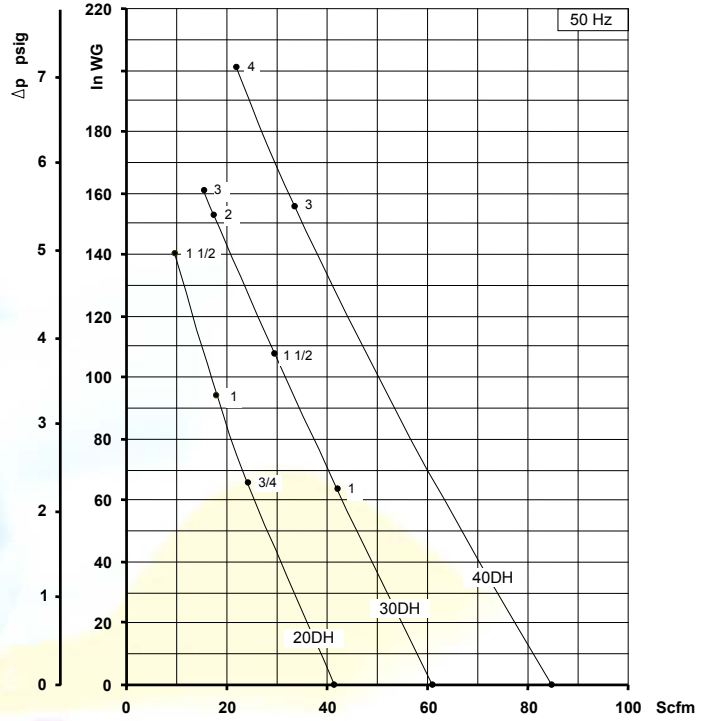
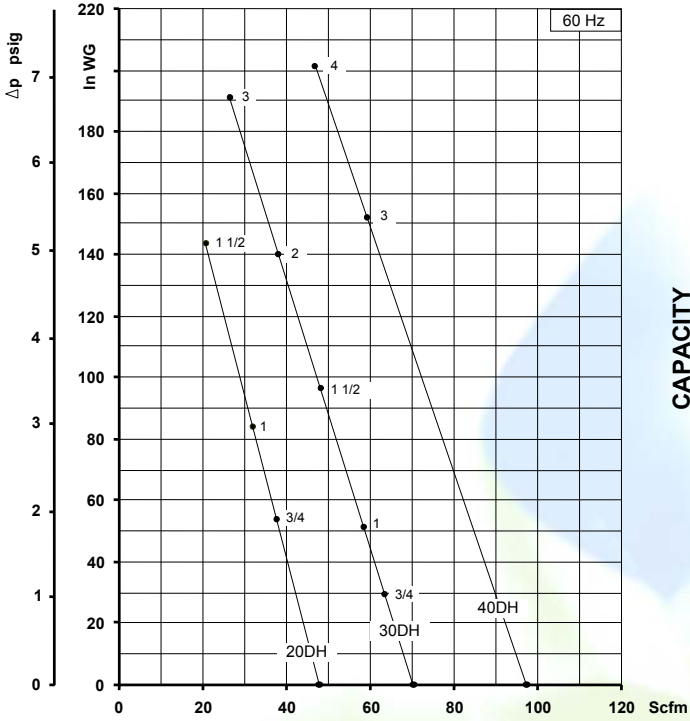

Curves refer to air at 68°F temperature and 29.92 In Hg atmospheric pressure (abs) measured at inlet port.
 Values for flow, power consumption and temperature rise: +/-10% tolerance.
 Data subject to change without notice.