



**FPZ, Inc**  
 150 N. Progress Drive  
 Saukville, WI 53080 - U.S.A.  
 Tel. (262) 268-0180  
 Fax (262) 268-0415  
 E-mail usa@fpz.com

REGENERATIVE BLOWERS - PRESSURE  
**SCL K03 / K04 / K05 / K06**  
**TD SERIES - MOR RANGE**  
 SN 1931-3 1/2

**TECHNICAL CHARACTERISTICS**

- Aluminium alloy construction
- Smooth operation
- High efficiency impeller
- Maintenance free
- Mountable in any position

**OPTIONS**

- Special voltages (IEC 38)
- Surface treatments

**ACCESSORIES**

- Inlet and/or inline filters
- Additional inlet/outlet silencers
- Safety valves
- Flow converting device
- Optional connectors

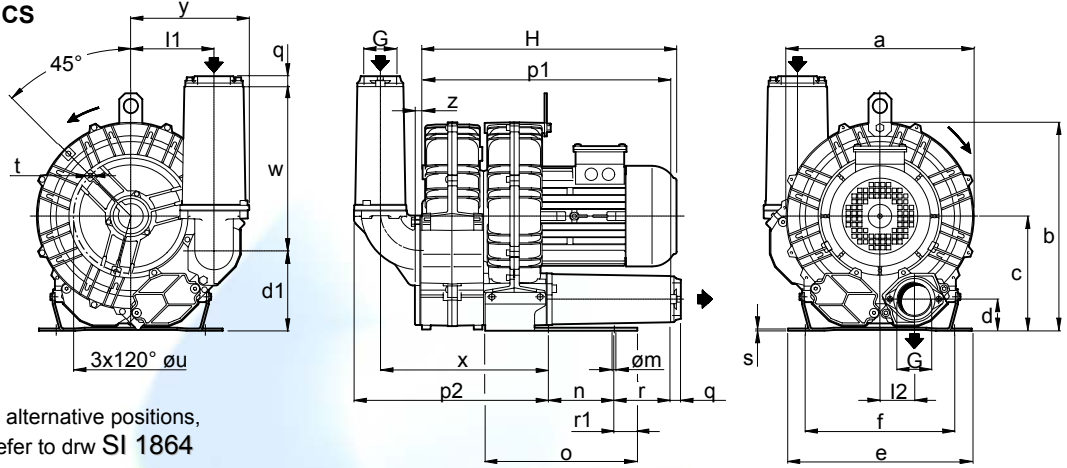

Possible alternative positions,  
 please refer to drw SI 1864

Dimensions in inches.  
 Dimension for reference only.

Model	a	b	c	d	d1	e	f	G	l1	l2	m	n	o	p1	p2	q	r	r1	s	t	u	w	x	y	z
<b>K03-TD</b>	9.49	10.55	5.79	1.69	4.09	9.06	8.07	1" 1/4 NPT	4.09	1.69	0.39	3.27	5.59	8.19	8.46	0.71	2.95	0.51	0.16	M6	5.51	7.40	7.09	5.75	0.47
<b>K04-TD</b>	11.22	12.40	6.77	1.93	4.76	10.04	8.86	1" 1/2 NPT	4.84	2.01	0.47	3.74	6.73	12.44	10.00	0.71	2.76	0.59	0.16	M6	6.89	7.40	8.43	6.81	0.71
<b>K05-TD</b>	12.87	14.37	7.87	2.13	5.51	12.60	10.24	2" NPT	5.71	2.36	0.59	4.53	10.43	16.85	13.39	0.71	3.86	1.57	0.16	M8	7.87	11.26	11.54	8.11	0.75
<b>K06-TD</b>	14.80	16.54	9.13	2.32	6.69	12.80	11.42	2" NPT	5.94	2.87	0.59	5.51	10.43	19.92	13.94	0.71	5.35	0.75	0.16	M8	9.45	11.26	12.13	8.27	0.75

Model	Maximum flow Scfm		Installed power Hp		Maximum differential pressure Δp (In WG)		Noise level Lp dB (A) <sup>(1)</sup>		Overall dimensions H Inches	Weight Lbs
	60 Hz 3500 rpm	50 Hz 2900 rpm	60 Hz 3500 rpm	50 Hz 2900 rpm	60 Hz 3500 rpm	50 Hz 2900 rpm	60 Hz 3500 rpm	50 Hz 2900 rpm		
<b>K03-TD</b>	52	43	1 1/2	1 1/2	90	120	68.0	66.0	14.88	43.43
			2	2	70	95	71.0	69.0		
<b>K04-TD</b>	99	82	3	3	130	160	72.0	70.0	15.91	58.40
			3	3	70	95	73.0	71.0		
<b>K05-TD</b>	153	127	4	4	105	135	74.5	72.5	17.32	79.40
			5 1/2	5 1/2	150	190	76.0	74.0		
			5 1/2	5 1/2	80	120	75.0	73.0		
<b>K06-TD</b>	222	184	7 1/2	6 1/4	125	140	76.0	74.0	19.09	88.20
			10	8 1/3	180	200	77.0	75.0		
			10	8 1/3	180	200	77.0	75.0		

(1) Noise measured at 1 m distance with inlet and outlet ports piped, in accordance to ISO 3744.

- For proper use, the blower should be equipped with inlet filter and safety valve; other accessories available on request.
- Ambient temperature from +5° to +104°F.
- Specifications subject to change without notice.

**F.P.Z. effepizeta s.r.l.**  
 Via F.lli Cervi 16/18  
 20049 Concorezzo - (MI) - ITALIA  
 Tel. +39 039 604 1820  
 Fax +39 039 604 1296  
 E-mail italia@fpz.com

**FPZ UK LTD**  
 Grateley Business Park,  
 Cholderton Road Grateley Andover  
 HAMPSHIRE, SP11 8SH - UNITED KINGDOM  
 Tel. +44 1264 889001  
 Fax +44 1264 889003  
 E-mail uk@fpz.com

**F.P.Z. France S.a.r.l.**  
 P.A Europe - 10 rue d'Italie  
 69780 - Mions - FRANCE  
 Tel. +33 (0)472 50 13 13  
 Fax +33 (0)472 50 03 40  
 E-mail france@fpz.com

**F.P.Z. GmbH**  
 Kilianstraße 142  
 90425 Nürnberg - DEUTSCHLAND  
 Tel. +49 (0)911 36 78 68-00  
 Fax +49 (0)911 36 78 68-01  
 E-mail deutschland@fpz.com

**FPZ IBERICA S.L.**  
 Poligono Ind. Errota Nave 5E  
 20270 - ANOETA GIPUZKOA - ESPAÑA  
 Tel. +34 943 653 942  
 Fax +34 943 653 943  
 E-mail iberica@fpz.com



REGENERATIVE BLOWERS - PRESSURE  
**SCL K03 / K04 / K05 / K06**  
**TD SERIES - MOR RANGE**  
 SN 1931-3 2/2

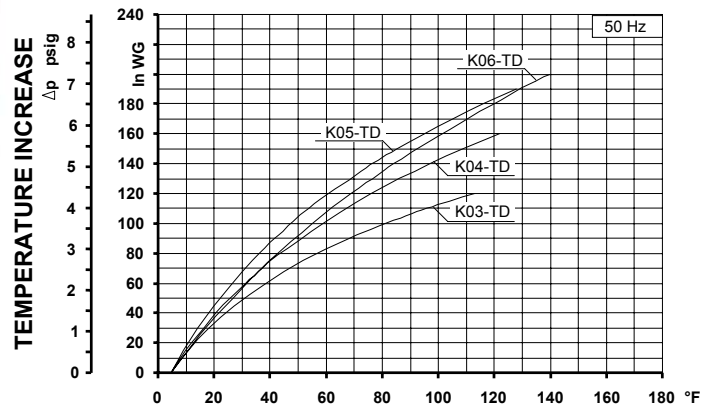
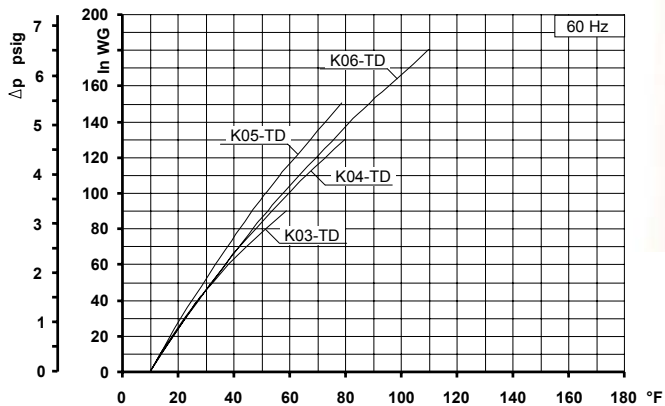
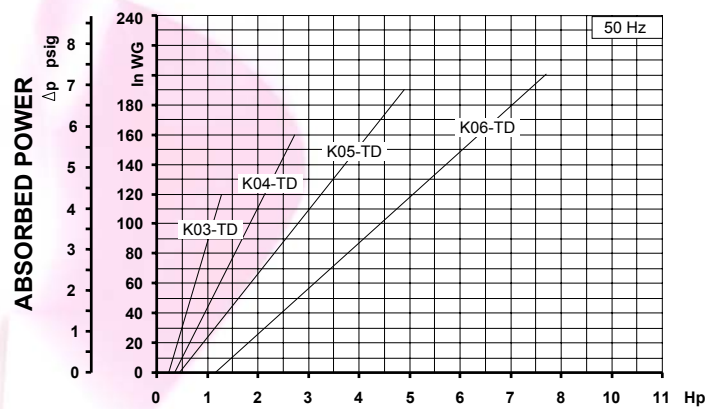
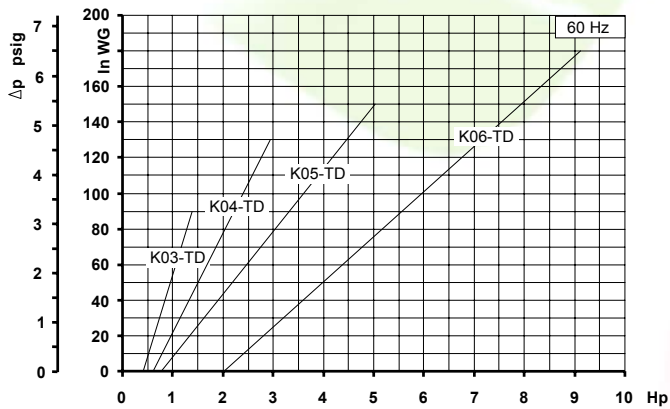
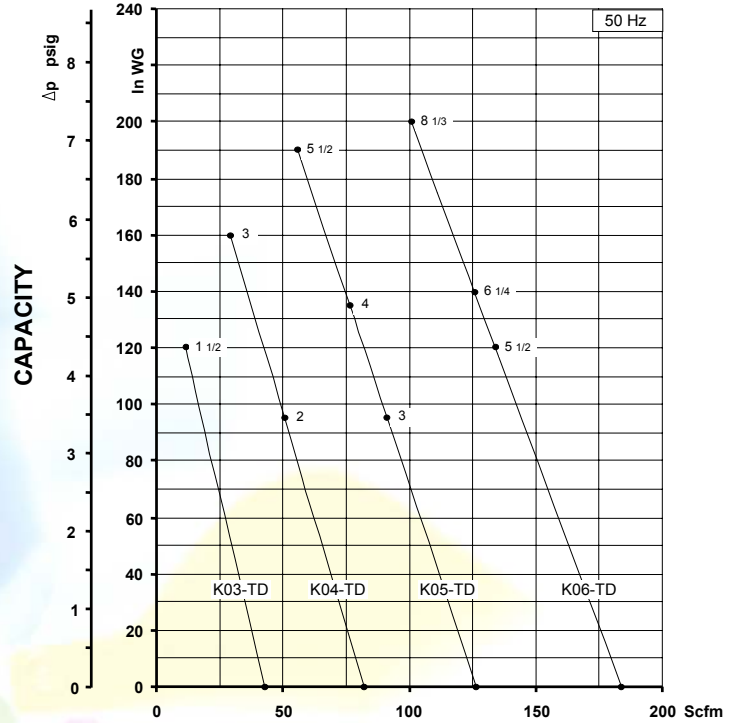
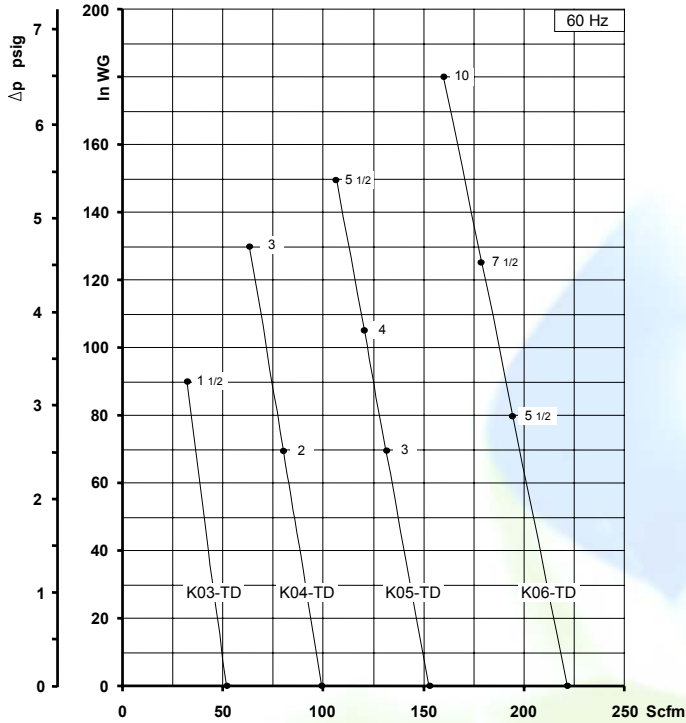

Curves refer to air at 68°F temperature and 29.92 In Hg atmospheric pressure (abs) measured at inlet port.  
 Values for flow, power consumption and temperature rise: +/-10% tolerance.  
 Data subject to change without notice.